

TECHNICAL DATA SHEET

SAFETY EDGES SENSOR DB-PSE series



Figure can vary

Contents

- Product application
- Model specification
- Technical data
- Installation instructions
- Precautions

Product application

The safety edge is a pressure-sensitive sensor in the form of a rubber band. Used to detect hazards such as crushing or shearing of people by moving parts. It is a close-up safety protection device for automatic equipment, which meets the highest safety protection requirements and is used to ensure the safety of people in dangerous areas that may be caught, squeezed, and bumped.

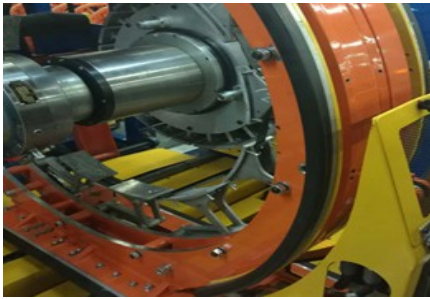

Features

- High trigger sensitivity, strong reliability, in line with the highest safety standards;
- Small size, suitable for use in narrow spaces;
- Can be installed with the type, according to the user's requirements, it can be applied to the anti-pinch protection occasions of circular arc or other shapes;
- Protection class IP65; meet extreme weather conditions, suitable for indoor or outdoor installation;
- It is suitable for various complex industrial occasions, and products with special requirements such as oil resistance and acid and alkali resistance can be selected.

The safety edge and the matching safety relay form a control area. Each control unit can be a safety edge, or multiple safety edges connected in series to form a control area. Series use of safety edges Up to several safety edges can be connected in series. But the maximum length of a control area (including link cables) should not be greater than 100 meters.

Usage restrictions

The safety edge and the matching safety relay form a control area. Each control unit can be a safety edge, or multiple safety edges connected in series to form a control area. Series use of safety edges Up to several safety edges can be connected in series. But the maximum length of a control area (including link cables) should not be greater than 100 meters.

The specifications of DB-PSE series safety edges are as follows:

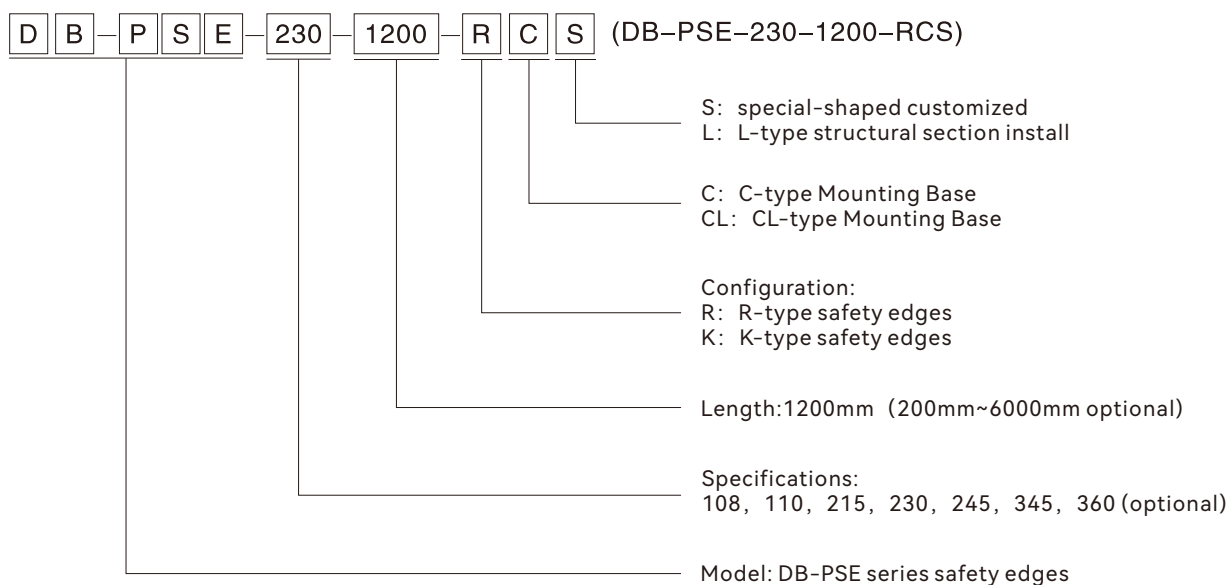

1. Product model specification

- Trigger distance - the distance from touching the safety edge to the trigger signal of the safety edge.
- Overtravel - the distance from the output of the safety edge trigger signal to the end of the safety edge buffer.

Model	Dimensions	Trigger distance	Trigger force	Overtravel
DB-PSE-108	8mm*15mm	< 2mm	≤25N	0
DB-PSE-110	10mm*15mm	< 2mm	≤25N	0
DB-PSE-215	15mm*25mm	< 3mm	≤25N	0
DB-PSE-230	30mm*25mm	< 3mm	≤25N	< 19mm
DB-PSE-245	45mm*25mm	< 3mm	≤25N	< 30mm
DB-PSE-345	45mm*35mm	< 5mm	≤100N	< 30mm
DB-PSE-360	60mm*35mm	< 5mm	≤100N	< 45mm

2. Boundary dimensions of safety edges

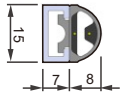
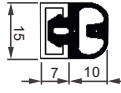
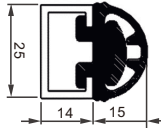
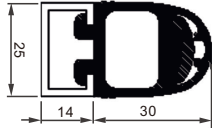
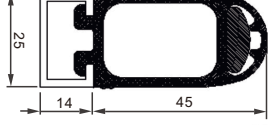
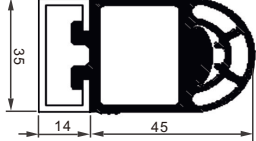
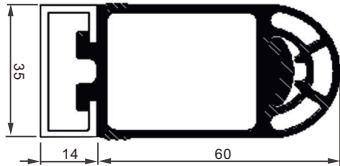
Model	Outline Dimensional	Sheathing material	Applications
DB-PSE-108		TPE	Small AGV
DB-PSE-110		TPE	Small AGVs, garage access control, industrial applications, etc
DB-PSE-215		EPDM	AGV, electric door Industrial applications
DB-PSE-230		EPDM	AGV, electric door Industrial applications
DB-PSE-245		EPDM	AGV, electric door Industrial applications
DB-PSE-345		EPDM	Large AGV anti-collision, heavy-duty industrial doors, machinery, and industrial applications
DB-PSE-360		EPDM	Large AGV anti-collision, heavy-duty industrial doors, machinery, and industrial applications

3. Boundary dimensions of safety contacts

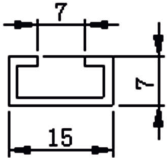
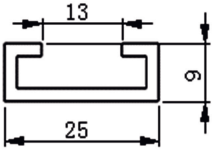
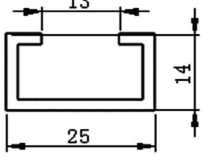
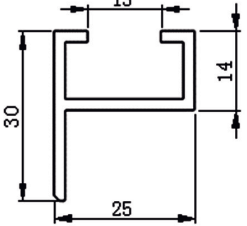
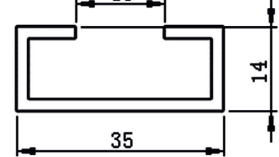
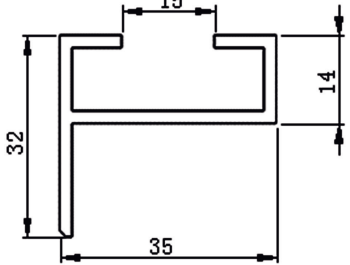
Base specifications	Overall dimensions	Applicable model
15mm C-type base		Suitable for DB-PSE-108, DB-PSE-110 series safety edges
25mm C-type base		Suitable for DB-PSE-215, DB-PSE-230 and DB-PSE-245 series safety edges
25mm C-type base		Suitable for DB-PSE-215, DB-PSE-230 and DB-PSE-245 series safety edges
25mm CL-type base		Suitable for DB-PSE-215, DB-PSE-230 and DB-PSE-245 series safety edges
35mm C-type base		Suitable for DB-PSE-345, DB-PSE-360 series safety edges
35mm CL-type base		Suitable for DB-PSE-345, DB-PSE-360 series safety edges

4. Function type

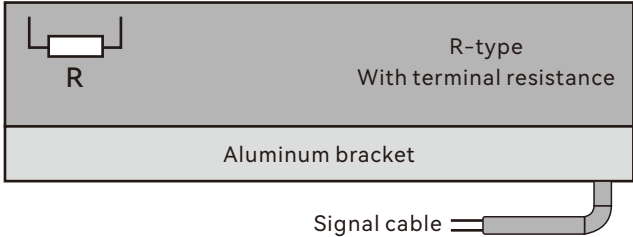
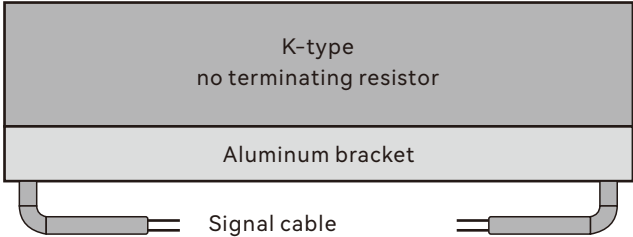
R-type safety edges	K-type safety edges
 <p>R-type With terminal resistance</p> <p>Aluminum bracket</p> <p>Signal cable</p>	 <p>K-type no terminating resistor</p> <p>Aluminum bracket</p> <p>Signal cable</p>
<p>TPE sheathed cable VVR $\phi 4\text{mm}$ $2 * 0.35\text{mm}^2$ (Red/black core) Cable length 2 meters, encapsulated terminal resistance (R=1.2KΩ or 8.2 KΩ)</p>	<p>TPE sheathed cable VVR $\phi 4\text{mm}$ $2 * 0.35\text{mm}^2$ (Red/black core) Cable length 2 meters</p>

5. Effective length

The length of the safety edge is generally 200mm~6000mm. There is a non-inductive zone at both ends of the safety contact edge.

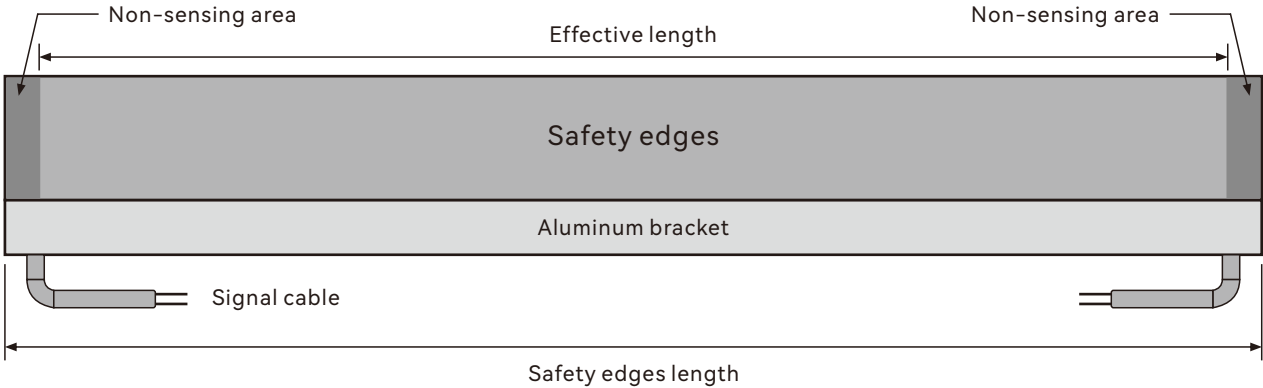
	
TPE sheath type	EPDM sheath type
Non-sensing area 20mm	Non-sensing area 25mm

Technical data

Basic data	
Product model	DB-PSE series
Detection method	Pressure sensing method
Maximum sensing angle	<90°
Trigger force	≥ 25N-250N (according to specifications and usage)
Mechanical life	> 3000000 times
Surface protection material	EPDM rubber Cr rubber
Ambient temperature	-20 °C --+55 °C
Protection level	IP65
Maximum humidity (23 %RH)	95% (condensation)
Response time	13ms

Security classification	
EN1760-1: Reset command	Support
ISO 138491-1:2005	Classification 3
MTTF _d	>30 years
B _{10d}	3* 10 ⁷
N _{op} (accepted)	52560/year
IEC 61508: PFHs	6.99 * 10 ⁻¹⁰ 1/h (SIL3)

The safety contact system composed of DB-PSE type safety contacts and QSRN, Ter-A type safety relays meets the following standards: EN1760-2; ISO13856-2; EN62061; EN ISO13849-1; IEC61508; EN60204-1.

1. Safety edge custom standard

Safety edge jacket material	Model
TPE	DB-PSE-108 and 110 seires
EPDM	DB-PSE-215/230/245/345/360 seires
SBR, CR, NBR	Custom made
Operating temperature	-20°C ~ +55°C
Safety standard	EN1760-2
Degree of protection	IP65

2. Safety Edge Physical Properties

Material	EPDM	TPE
Tear strength	Better	Better
Ultimate tensile strength	Good	Better
Resilience (20°C)	Good	Good
Plastic deformation resistance	Good	Generally
Wear and tear	Better	Better
Extendable length	Generally	Generally
Low temperature elasticity	Good	Good

3. Safety Edge chemical barrier

Solution name	EPDM	TPE
Dilute acid	+	+
Dilute alkali	+	+
Non-oxidizing acid	+	±
Metal working oil	±	±
Vegetable oil	+	+
Ester solvent	+	±
Solvent (gasoline)	±	-
Aromatic hydrocarbons	-	-
Alcohol	+	+
Ammonia	+	±
Brake fluid	+	+
Cutting emulsion	+	+
Acetic acid	+	±
Acetone	+	±
Potash fertilizer	+	+
Methanol	+	±
Thinner	-	-
Water	+	+

4. Safety Edge environmental tolerance

Material	EPDM	TPE
high temperature stability	Very good	Generally
Oxidative stability	Very good	Very good
UV stability	Very good	Very good
Climate/ozone resistant	Very good	Very good
Gas permeability	Very good	Very good
Flame retardancy	Good	bad

Installation instructions

1. Safety edge installation features

If the installation angle is larger than the maximum bending angle, the safety way of safety touch edge segmented series connection can be considered.



The safety edge can be bent and installed at a certain angle, and the maximum allowable bending angle is shown in the table below.

Maximum bending angle				Image
Model	A	B	C	
DB-PSE-108	20°	20°	15°	
DB-PSE-110	20°	20°	15°	
DB-PSE-215	20°	20°	20°	
DB-PSE-230	20°	20°	15°	
DB-PSE-245	15°	15°	10°	
DB-PSE-345	15°	15°	10°	
DB-PSE-360	15°	15°	10°	

The safety contact edge can be installed and used in a circular arc shape, and the allowable minimum bending radius is shown in the table below.

Minimum bending radius (mm)				Image
Model	R1	R2	R3	
DB-PSE-108	200	300	50	
DB-PSE-110	200	350	150	
DB-PSE-215	350	350	150	
DB-PSE-230	350	450	300	
DB-PSE-245	350	450	450	
DB-PSE-345	400	450	450	
DB-PSE-360	400	500	450	

2. Selection of safety edges controller

Name	Order separately	Model	Descriptions
Safety relay	  Multifunction switching switch	Ter-A	Equipped with a mode switch, it can be used for most safety components, such as light curtains, safety switches, carpet contacts, two handed switches, etc. Automatic/manual reset paddles for quick configuration. Dual channel monitoring circuit, safe and reliable.

2.1 security touch system configuration

System configuration of sensor mode safety relay

The safety contacts and safety relays form a complete safety protection system. According to the requirements, a protection system can be composed of a safety relay with one safety contact, multiple safety contacts, or a series combination of safety contacts and safety carpets to form a safety protection system.

1) Sensing output -1 safety contact safety protection system:

a. 2-wire edges connected relay Ter-A safety input with manual reset

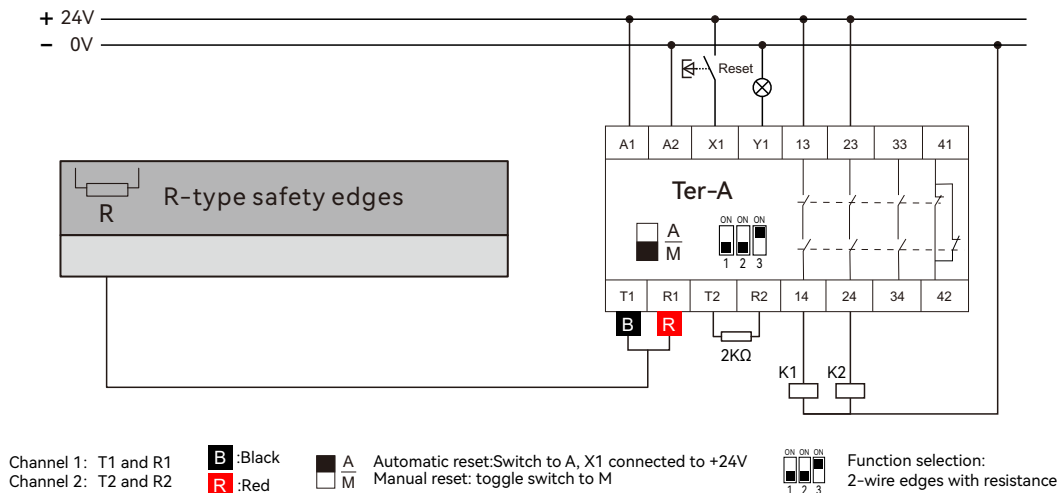

b. Dual channel 4-wire edges connected relay Ter-A safety input with manual reset

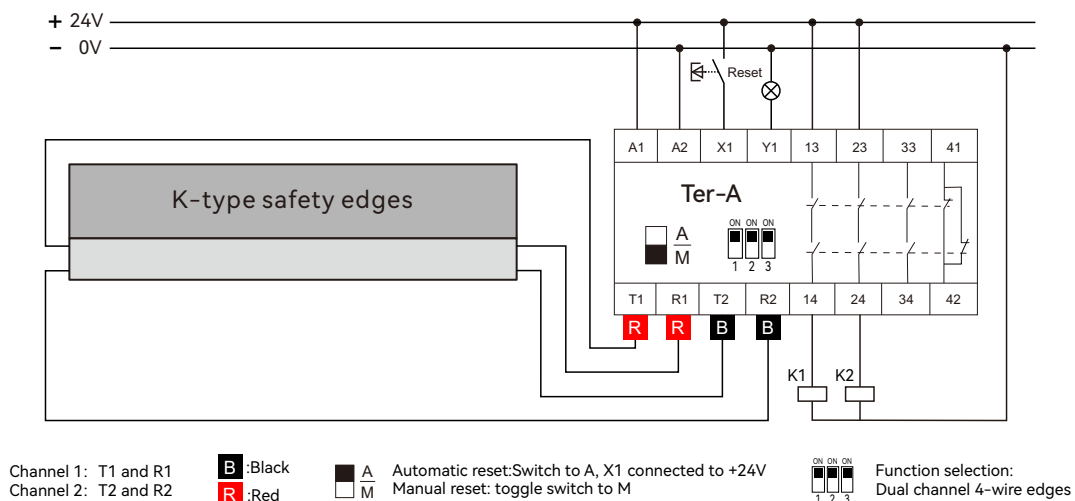

2) Sensing output – a combination of multiple safety edges connected in series
R/K series combination of safety edges

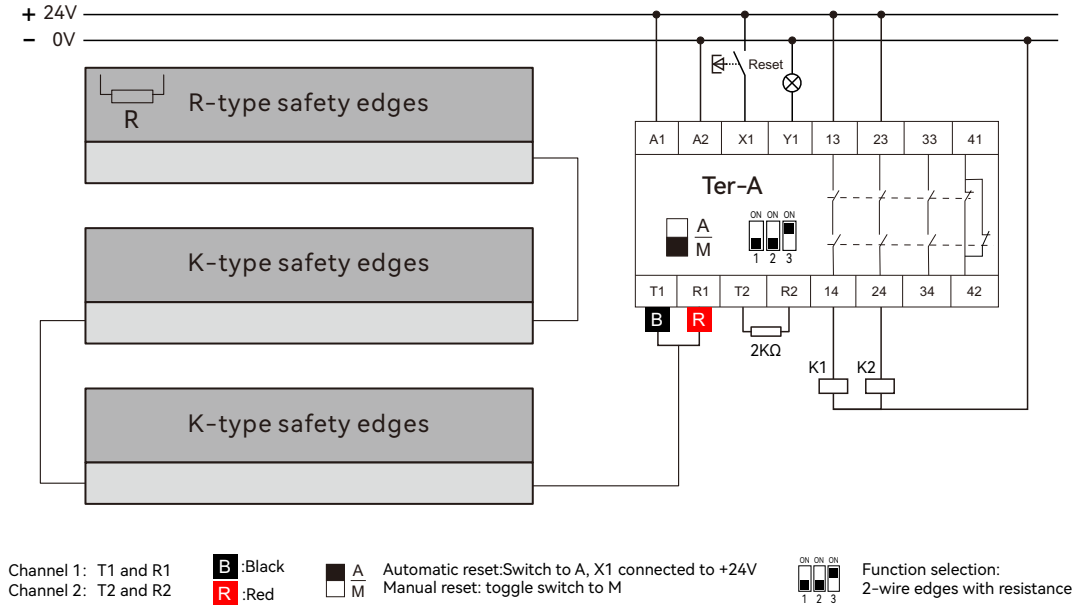

3) K/K series combination of safety edges

This combination is generally used for safety protection systems with multiple safety edges in sensor output mode, single zone Control multiple safety edge situations. This series connection can be used with up to 10 safety edges in series.

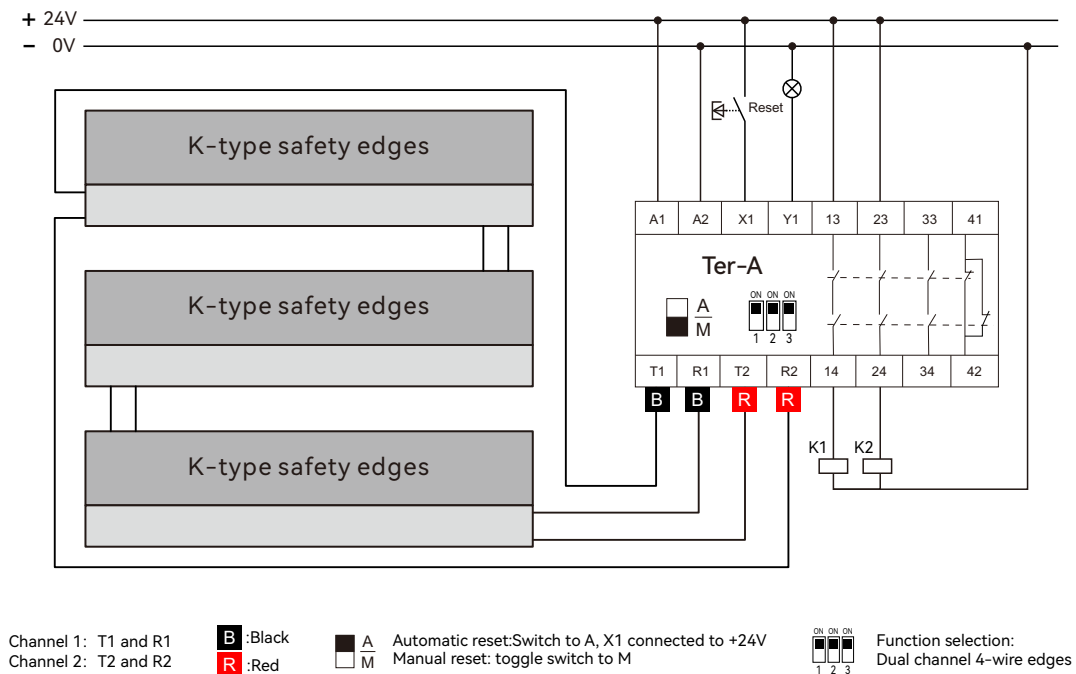

Precautions

1. Precautions for storage and use environment

- Do not store or use this product under long-term direct sunlight;
- Do not store and use the ambient temperature outside the range of -35°C to +80°C;
- Do not store and use outside the air pressure range of 86~106KPa;
- Do not store and use in environments containing strong corrosive or flammable gases.

2. Precautions for installation

- Do not lift or move the safety edge by pulling on the cable ;
- Please use the special bracket to install the safety edge ;
- Do not fold or punch holes in the safety edge ;
- Do not install the Safety Edge on raised areas of the surface, but on a flat, smooth surface.

3. Precautions for use

- Be sure to use the safety edge with the matching safety relay in this instruction ;
- The safety edge cannot be directly connected to the switch contacts of ordinary intermediate relays for use;
- It is not possible to connect the safety edge directly to the PLC for use;
- Do not apply load to a certain position of the safety edge for a long time, otherwise it may cause damage to the safety edge;
- Do not immerse the safety edge in water or use it in frequent water splashing;
- Please use it strictly according to the chemical resistance of the product.